

Boîte avec membrane élastique

Cette nouveauté brevetée, fabriquée par Inca Plastic SA, permet d'emballer des objets délicats, ronds, pointus ou difformes de différentes grandeurs, sans risque d'oxydation. La transparence de l'emballage permet un contrôle visuel. Les couvercles et les fonds sont interchangeables. Toutes les boîtes peuvent être personnalisées (logo, adjonction de séparations).

Une boîte avec membrane est composée de 2 demi-boîtes en polystyrol munie d'une membrane très mince en polyuréthane. Les objets se trouveront pincés et suspendus à l'intérieur de la boîte. Des charnières et crochets de fermeture permettent une réutilisation de l'emballage.

La profondeur d'une des demi-boîtes peut être différente de l'autre. Les commandes de ces emballages doivent se faire par demi-boîte, non assemblées, ce qui permet de varier la profondeur de l'emballage selon la forme des pièces à emballer.

Les n° d'articles figurant dans nos listes concernent toujours les demi-boîtes. Il est donc possible de commander une demi-boîte de 100 mm de longueur, 50 mm de large, 8 mm de profondeur avec une demi-boîte de 100 mm de long., 50 mm de large, 25 mm de profondeur.

Les boîtes qui contiennent un objet doivent voyager par avion dans des **soutes pressurisées**.

Boîtes rectangulaires avec membrane		3-22
Cadres avec membrane		23a
Boîtes en grappe avec membrane		24
Boîtes rondes avec membrane		25
Boîte étanche avec membrane élastique		25a
Cadres pliables avec membrane élastique		25b
Boîte à membrane avec pitons pour 10/20/30 cadrans		25c
Plateaux empilables		26

Boîtes pour horlogers et industriels

Boîtes à fourniture				<u>31-39</u>
---------------------	--	--	--	--------------

1/2 boîte avec membrane élastique



Schéma	Longueur (1) mm	Largeur (2) mm	Hauteur (3) mm	Référence	Quantité	
	50	50	8	3		S
			12.5	4		S
	75	50	8	5		S
			12.5	6		S
	75	75	8	7		S
			12.5	8		S
	100	50	8	11		S
			12.5	12.1		S
			25	13		S
	100	75	8	22		S
			12.5	23		S
			25	24		S
			37.5	25		S
	100	100	8	31		S
			12.5	32		S
			25	33		S
			37.5	34		S
			50	35		S
	100	100	8	36		S
			12.5	37		S
			25	38		S
			37.5	39		S
			50	40		
	125	50	8	44		S
			12.5	45		S
			25	46		S
	125	75	8	55		S
			12.5	56		S
			25	57		S
			37.5	58		

- L = Crochet d'ouverture

- C = Charnière

- Les numéros d'article concernent toujours des 1/2 boîtes

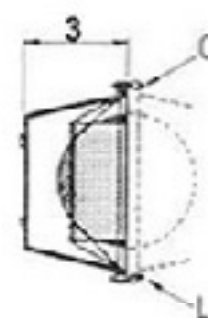
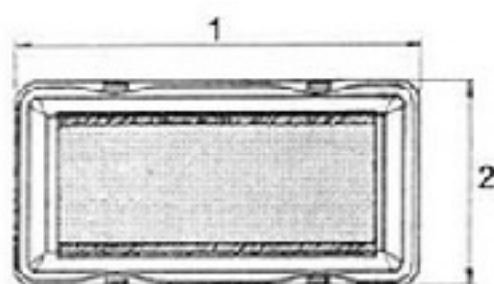
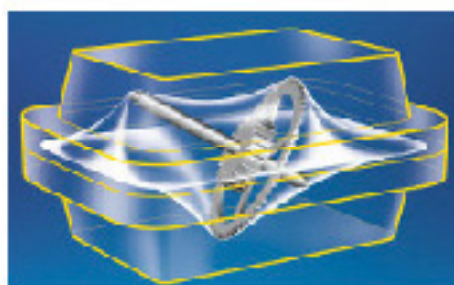
- S = Livrable du stock (sans frais d'outillage)

1/2 boîte avec membrane élastique

4



Schéma	Longueur (1) mm	Largeur (2) mm	Hauteur (3) mm	Référence	Quantité	
	125	100	8	74		S
			12.5	75		
			25	76		
			37.5	77		
			50	78		S
	125	125	8	96		S
			12.5	97		S
			25	98		S
			37.5	99		S
			50	100		
			62.5	101		
	125	125	8	102		S
			12.5	103		S
			25	104		S
			37.5	105		
			50	106		S
			62.5	107		
	150	50	8	114		S
			12.5	115		S
			25	116		S
	150	50	8	117		S
			12.5	118		S
			25	119		
	150	75	8	128		
			12.5	129		S
			25	130		S
			37.5	131		

- L = Crochet d'ouverture

- C = Charnière

- Les numéros d'article concernent toujours des 1/2 boîtes

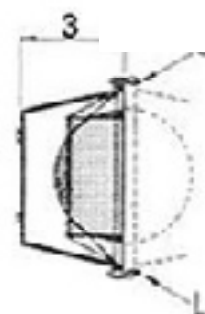
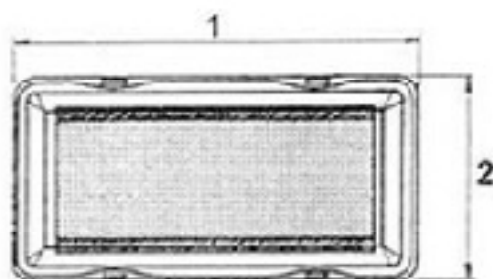
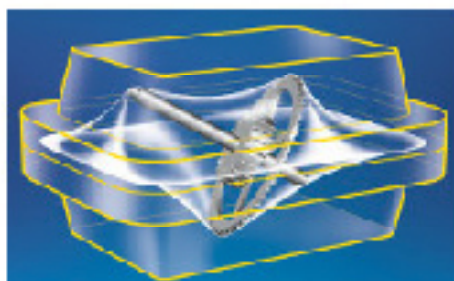
- S = Livrable du stock (sans frais d'outillage)

1/2 boîte avec membrane élastique

5



Schéma	Longueur (1) mm	Largeur (2) mm	Hauteur (3) mm	Référence	Quantité	
	150	100	8	147		S
			12.5	148		S
			25	149		S
			37.5	150		S
			50	151		S
	150	100	8	153		S
			12.5	154		S
			25	155		S
			37.5	156		S
			50	157		
	150	125	8	183		S
			12.5	184		S
			25	185		S
			37.5	186		S
			50	187		
			62.5	188		
	150	125	8	195		
			12.5	196		
			25	197		S
			37.5	198		
			50	199		
			62.5	200		

- L = Crochet d'ouverture

- C = Charnière

- Les numéros d'article concernent toujours des 1/2 boîtes

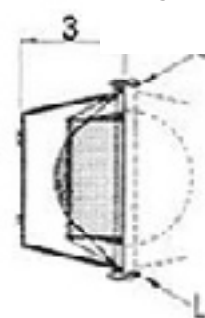
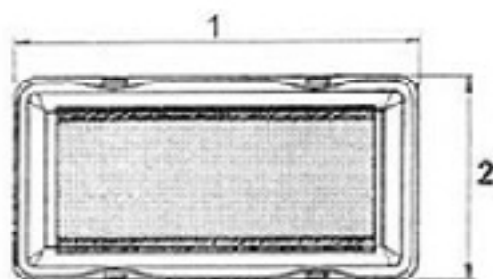
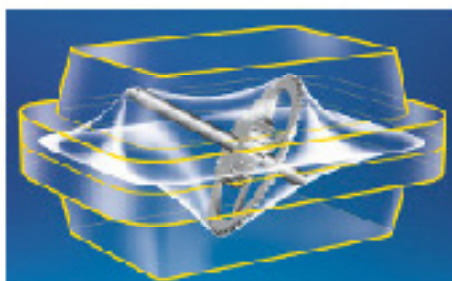
- S = Livrable du stock (sans frais d'outillage)

1/2 boîte avec membrane élastique

6



Schéma	Longueur (1) mm	Largeur (2) mm	Hauteur (3) mm	Référence	Quantité	
	150	150	8	222		S
			12.5	224		S
			25	225		S
			37.5	226		S
			50	227		S
			62.5	228		
			75	230		
	175	50	8	237		
			12.5	238		S
			25	239		S
	175	50	8	240		
			12.5	241		
			25	242		
	175	75	8	247		
			12.5	248		
			25	249		
	175	75	8	251		
			12.5	252		S
			25	253		S
			37.5	254		
	175	75	8	255		
			12.5	256		
			25	257		
			37.5	258		
	175	100	8	274		

- L = Crochet d'ouverture

- C = Charnière

- Les numéros d'article concernent toujours des 1/2 boîtes

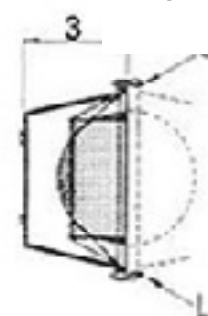
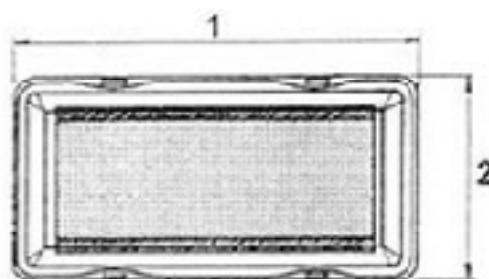
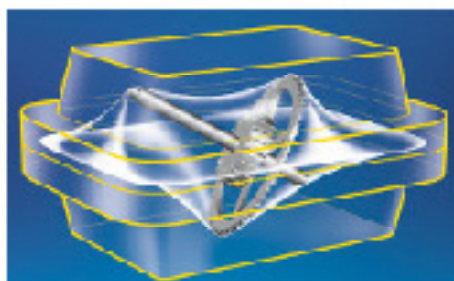
- S = Livrable du stock (sans frais d'outillage)

1/2 boîte avec membrane élastique

7



Schéma	Longueur (1) mm	Largeur (2) mm	Hauteur (3) mm	Référence	Quantité	
	175	100	12.5	275		S
			25	276		S
			37.5	277A		
			50	278		
	175	100	8	284A		
			12.5	285		S
			25	286		
			37.5	287		
	175	125	50	288		
			8	312		
			12.5	313		
			25	314		S
	175	125	37.5	315		S
			50	316		
			62.5	317		
			8	324		
	175	125	12.5	325		
			25	326		S
			37.5	327		S
			50	328		
	175	150	62.5	329		
			8	357		
			12.5	358		
			25	359		S
	175	150	37.5	360		
			50	361		
			62.5	362		
			75	363		

- L = Crochet d'ouverture

- C = Charnière

- Les numéros d'article concernent toujours des 1/2 boîtes

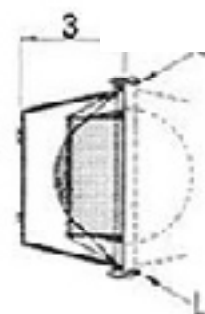
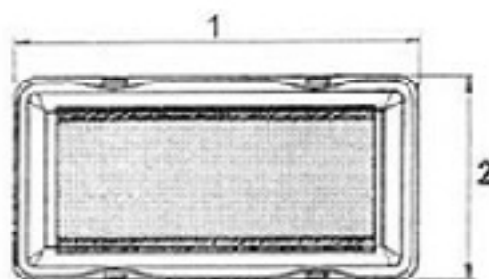
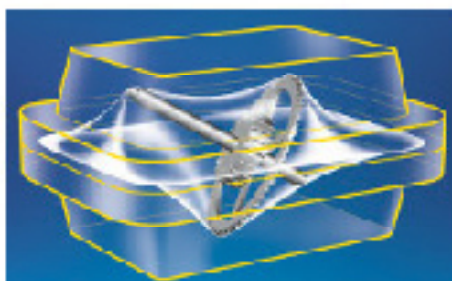
- S = Livrable du stock (sans frais d'outillage)

1/2 boîte avec membrane élastique

8



Schéma	Longueur (1) mm	Largeur (2) mm	Hauteur (3) mm	Référence	Quantité	
	175	150	8	371		
			12.5	372		
			25	373		S
			37.5	374		
			50	375		
			62.5	376		
			75	377		
	175	175	8	401		S
			12.5	402		
			25	403		S
			37.5	404		
			50	405		S
			62.5	406		
			75	407		
			87.5	408		
	175	175	8	409		S
			12.5	410		S
			25	411		S
			37.5	412		
			50	413		S
			62.5	414		
			75	415		S
			87.5	416		
	200	50	8	423		
			12.5	424		S
			25	425		S

- L = Crochet d'ouverture
- C = Charnière
- Les numéros d'article concernent toujours des 1/2 boîtes
- S = Livrable du stock (sans frais d'outillage)

1/2 boîte avec membrane élastique

9

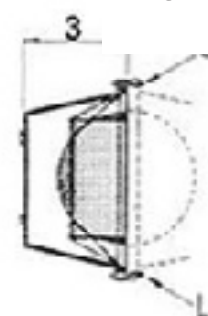
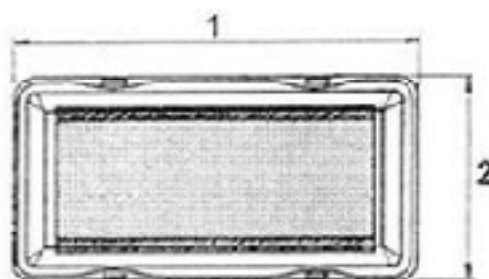
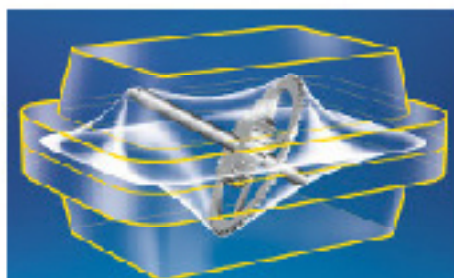

Schéma	Longueur (1) mm	Largeur (2) mm	Hauteur (3) mm	Référence	Quantité	
	200	50	8	426		
			12.5	427		S
			25	428		S
	200	75	8	437		S
			12.5	438		S
			25	439		S
			37.5	440		S
	200	75	8	441		
			12.5	442		S
			25	443		S
			37.5	444		
	200	100	8	460		S
			12.5	461		
			25	462		S
			37.5	463		
			50	464		
	200	100	8	465		
			12.5	466		
			25	467		S
			37.5	468		S
			50	469		
	200	125	8	493		S
			12.5	494		
			25	495		
			37.5	496		
			50	497		
			62.5	498		

- L = Crochet d'ouverture

- C = Charnière

- Les numéros d'article concernent toujours des 1/2 boîtes

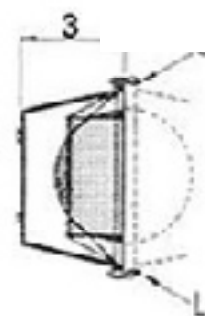
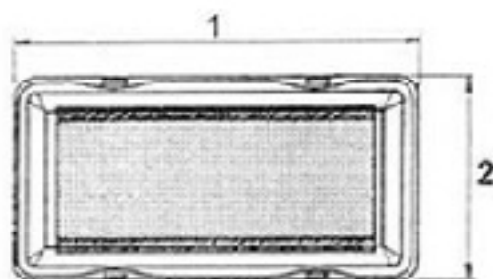
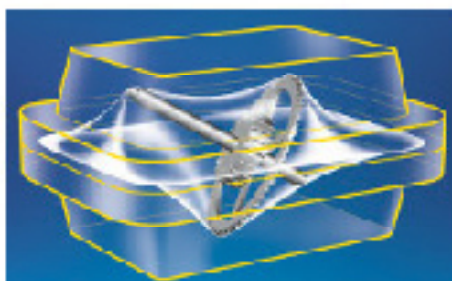
- S = Livrable du stock (sans frais d'outillage)

1/2 boîte avec membrane élastique

10



Schéma	Longueur (1) mm	Largeur (2) mm	Hauteur (3) mm	Référence	Quantité	
	200	125	8	505		S
			12.5	506		S
			25	507		S
			37.5	508		
			50	509		
			62.5	510		
	200	150	8	538		
			12.5	539		S
			25	540		S
			37.5	541		S
			50	542		S
			62.5	543		
	200	150	8	552		
			12.5	553		
			25	554		S
			37.5	555		S
			50	556		S
			62.5	557		
	200	175	8	590		
			12.5	591		
			25	592		S
			37.5	593		
			50	594		
			62.5	595		
			75	596		
87.5	597					

- L = Crochet d'ouverture

- C = Charnière

- Les numéros d'article concernent toujours des 1/2 boîtes

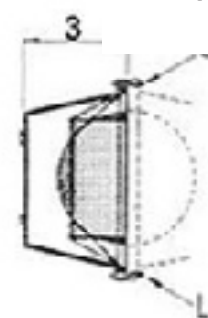
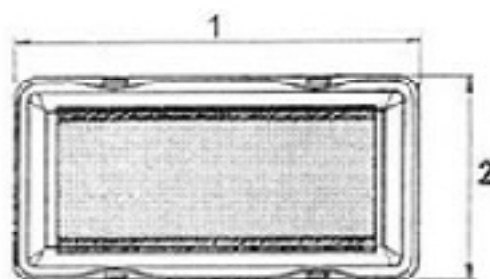
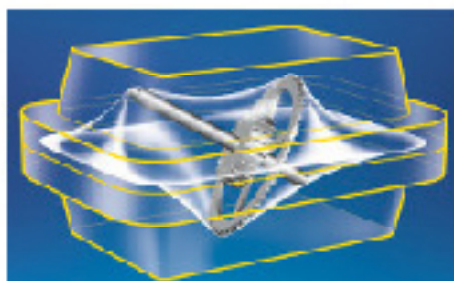
- S = Livrable du stock (sans frais d'outillage)

1/2 boîte avec membrane élastique

11



Schéma	Longueur (1) mm	Largeur (2) mm	Hauteur (3) mm	Référence	Quantité	
	200	175	8	606		
			12.5	607		
			25	608		S
			37.5	609		
			50	610		S
			62.5	611		
			75	612		
	200	200	8	640		
			12.5	641		S
			25	642		S
			37.5	643		
			50	644		
			62.5	645		
			75	646		
	200	200	8	649		S
			12.5	650		S
			25	651		S
			37.5	652		
			50	653		
			62.5	654		
			75	655		
			87.5	656		
100	657					

- L = Crochet d'ouverture
- C = Charnière
- Les numéros d'article concernent toujours des 1/2 boîtes
- S = Livrable du stock (sans frais d'outillage)

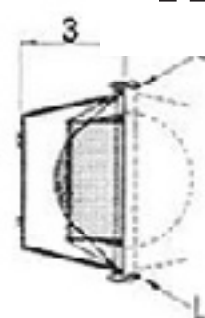
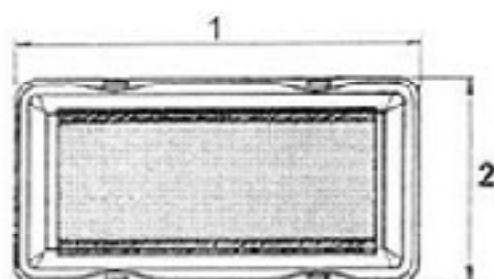
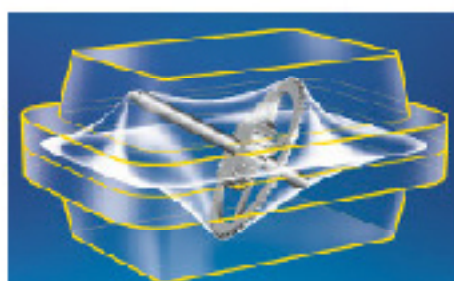

Schéma	Longueur (1) mm	Largeur (2) mm	Hauteur (3) mm	Référence	Quantité	
	225	50	8	664		
			12.5	665		
			25	666		
	225	50	8	667		
			12.5	668		
			25	669		S
	225	75	8	678		
			12.5	679		
			25	680		
			37.5	681		
	225	75	8	682		
			12.5	683		S
			25	684		
			37.5	685		
	225	100	8	701		
			12.5	702		
			25	703		
			37.5	704		
			50	705		
	225	100	8	706		
			12.5	707		
			25	708		S
			37.5	709		
			50	710		

- L = Crochet d'ouverture
- C = Charnière
- Les numéros d'article concernent toujours des 1/2 boîtes
- S = Livrable du stock (sans frais d'outillage)

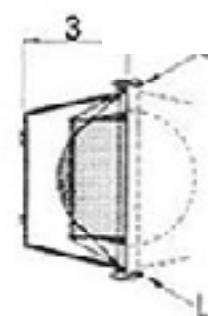
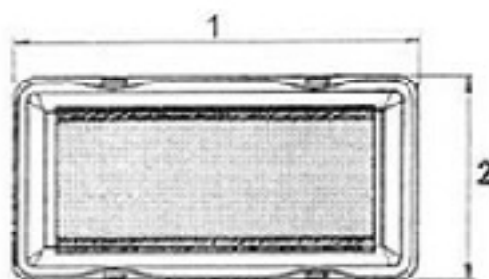
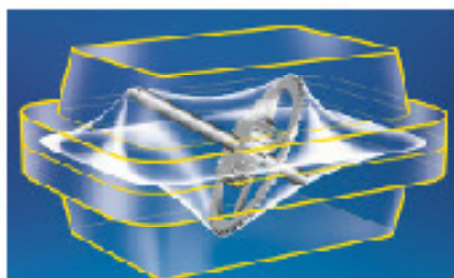

Schéma	Longueur (1) mm	Largeur (2) mm	Hauteur (3) mm	Référence	Quantité	
	225	125	8	736		
			12.5	737		S
			25	738		S
			37.5	739		
			50	740		
			62.5	741		
	225	125	8	748		
			12.5	749		S
			25	750		S
			37.5	751		
			50	752		
			62.5	753		
	225	150	8	781		
			12.5	782		
			25	783		
			37.5	784		
			50	785		
			62.5	786		
			75	787		
	225	150	8	795		
			12.5	796		
			25	797		S
			37.5	798		
			50	799		S
			62.5	800		
			75	801		

- L = Crochet d'ouverture
- C = Charnière
- Les numéros d'article concernent toujours des 1/2 boîtes
- S = Livrable du stock (sans frais d'outillage)

1/2 boîte avec membrane élastique

14

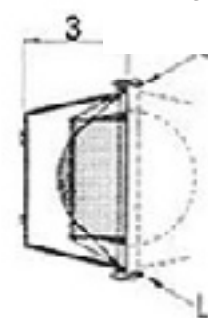
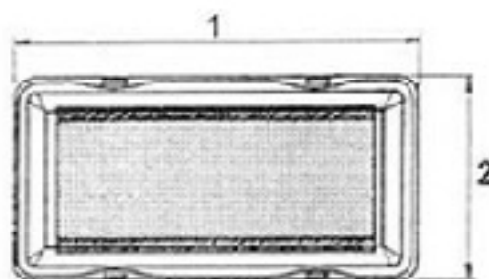
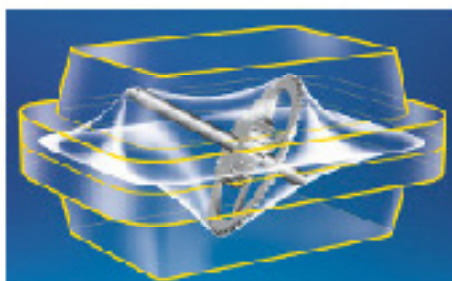

Schéma	Longueur (1) mm	Largeur (2) mm	Hauteur (3) mm	Référence	Quantité	
	225	175	8	833		
			12.5	834		
			25	835		
			37.5	836		
			50	837		
			62.5	838		
			75	839		
			87.5	840		
	225	175	8	849		
			12.5	850		
			25	851		S
			37.5	852		
			50	853		
			62.5	854		
			75	855		
			87.5	856		
	225	200	8	892		
			12.5	893		
			25	894		S
			37.5	895		
			50	896		
			62.5	897		
			75	898		
			87.5	899		
			100	900		

- L = Crochet d'ouverture

- C = Charnière

- Les numéros d'article concernent toujours des 1/2 boîtes

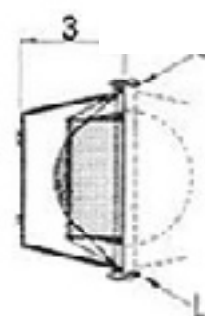
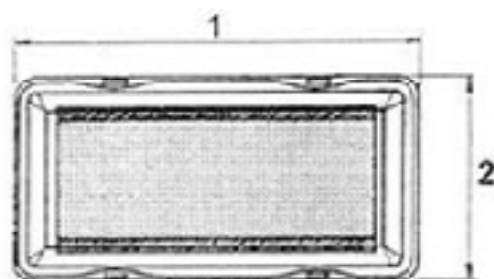
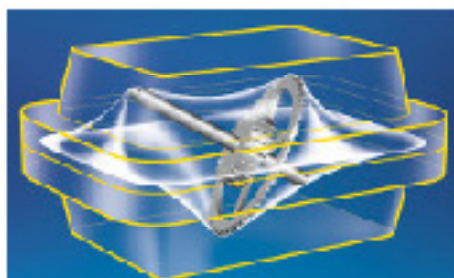
- S = Livrable du stock (sans frais d'outillage)



Schéma	Longueur (1) mm	Largeur (2) mm	Hauteur (3) mm	Référence	Quantité	
	225	200	8	910		
			12.5	911		S
			25	912		S
			37.5	913		
			50	914		
			62.5	915		
			75	916		
			87.5	917		
100	918					
	250	50	8	934		S
			12.5	935		
			25	936		S
	250	50	8	937		
			12.5	938		
			25	939		S
	250	75	8	948		
			12.5	949		
			25	950		
			37.5	951		
	250	75	8	952		
			12.5	953		S
			25	954		
			37.5	955		
	250	100	8	971		S
			12.5	972		S
			25	973		S
			37.5	974		
			50	975		

- L = Crochet d'ouverture
- C = Charnière
- Les numéros d'article concernent toujours des 1/2 boîtes
- S = Livrable du stock (sans frais d'outillage)

1/2 boîte avec membrane élastique

16

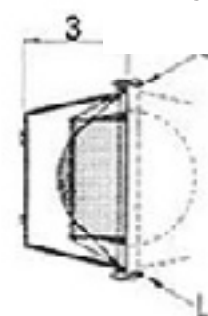
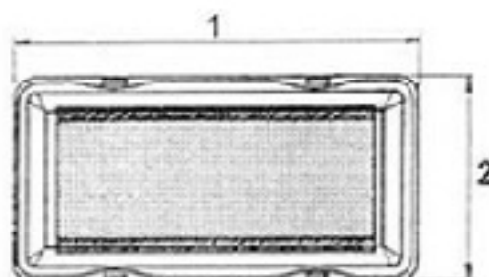
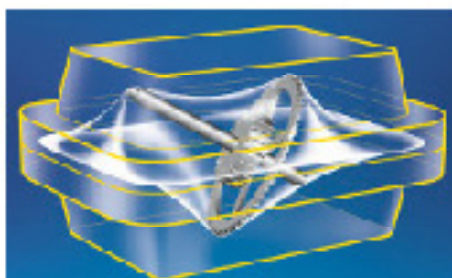

Schéma	Longueur (1) mm	Largeur (2) mm	Hauteur (3) mm	Référence	Quantité	
	250	100	8	976		
			12.5	977		S
			25	978		S
			37.5	979		
			50	980		S
	250	125	8	1004		S
			12.5	1005		
			25	1006		
			37.5	1007		
			50	1008		
			62.5	1009		
	250	125	8	1016		S
			12.5	1017		
			25	1018		S
			37.5	1019		
			50	1020		
			62.5	1021		
	250	150	8	1049		
			12.5	1050		
			25	1051		
			37.5	1052		
			50	1053		
			62.5	1054		
			75	1055		

- L = Crochet d'ouverture

- C = Charnière

- Les numéros d'article concernent toujours des 1/2 boîtes

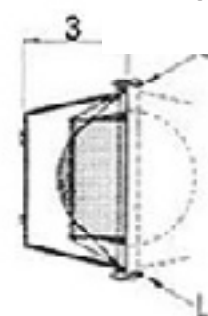
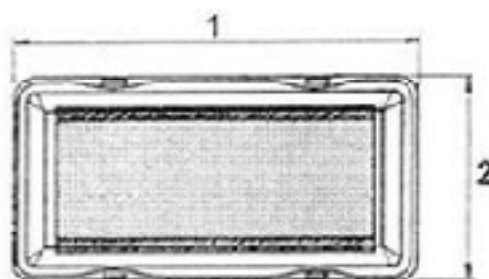
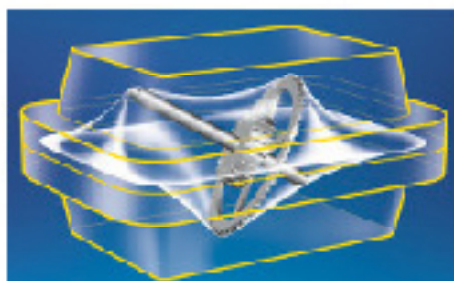
- S = Livrable du stock (sans frais d'outillage)



Schéma	Longueur (1) mm	Largeur (2) mm	Hauteur (3) mm	Référence	Quantité	
	250	150	8	1063		S
			12.5	1064		
			25	1065		S
			37.5	1066		S
			50	1067		
			62.5	1068		
			75	1069		
	250	175	8	1101		
			12.5	1102		
			25	1103		
			37.5	1104		
			50	1105		
			62.5	1106		
			75	1107		
			87.5	1108		
	250	175	8	1117		
			12.5	1118		
			25	1119		S
			37.5	1120		
			50	1121		
			62.5	1122		
			75	1123		
			87.5	1124		

- L = Crochet d'ouverture

- C = Charnière

- Les numéros d'article concernent toujours des 1/2 boîtes

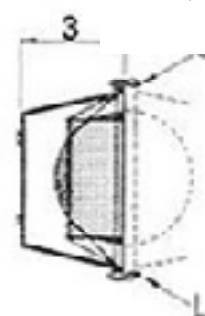
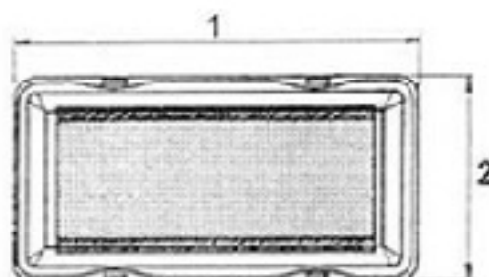
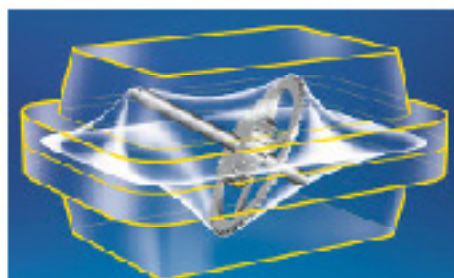
- S = Livrable du stock (sans frais d'outillage)



Schéma	Longueur (1) mm	Largeur (2) mm	Hauteur (3) mm	Référence	Quantité
	250	200	8	1160	
			12.5	1161	
			25	1162	
			37.5	1163	
			50	1164	
			62.5	1165	
			75	1166	
			87.5	1167	
	250	200	8	1178	
			12.5	1179	S
			25	1180	S
			37.5	1181	S
			50	1182	S
			62.5	1183	
			75	1184	
			87.5	1185	
	275	50	8	1202	
			12.5	1203 A	
			25	1204	
	275	50	8	1205 A	
			12.5	1206	
			25	1207	S
	275	75	8	1216 A	
			12.5	1217	
			25	1218	
			37.5	1219	

- L = Crochet d'ouverture
- C = Charnière
- Les numéros d'article concernent toujours des 1/2 boîtes
- S = Livrable du stock (sans frais d'outillage)

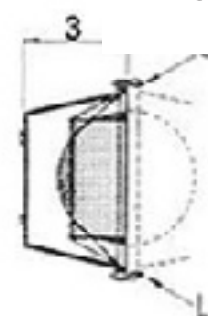
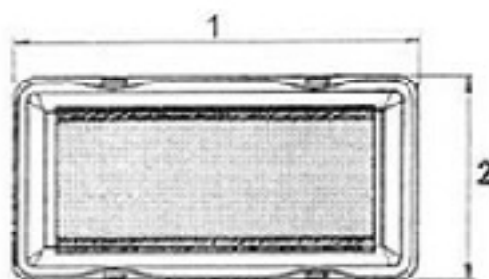
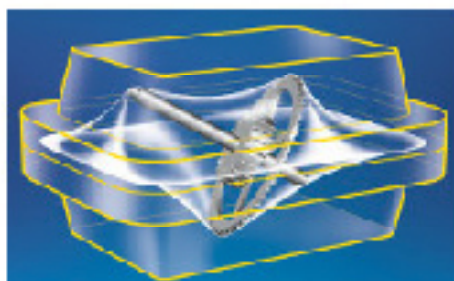

Schéma	Longueur (1) mm	Largeur (2) mm	Hauteur (3) mm	Référence	Quantité	
	275	75	8	1220 A		
			12.5	1221		S
			25	1222 A		
			37.5	1223 A		
	275	100	8	1239		
			12.5	1240 A		
			25	1241		S
			37.5	1242		
			50	1243		
	275	100	8	1244		S
			12.5	1245 A		
			25	1246 A		S
			37.5	1247		S
			50	1248 A		
	275	125	8	1267		
			12.5	1268		S
			25	1269		
			37.5	1270		
			50	1271		
			62.5	1272 A		
	275	125	8	1279 A		
			12.5	1280 A		
			25	1281		S
			37.5	1282		S
			50	1283		
			62.5	1284		

- L = Crochet d'ouverture
- C = Charnière
- Les numéros d'article concernent toujours des 1/2 boîtes
- S = Livrable du stock (sans frais d'outillage)

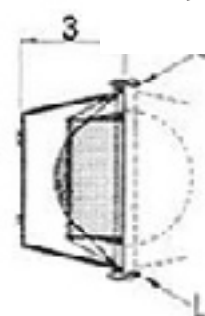
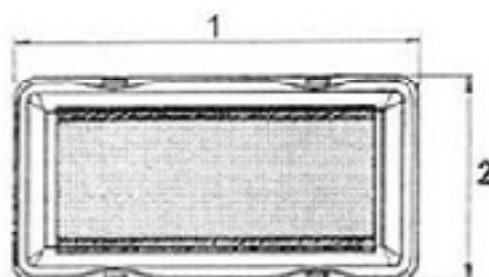
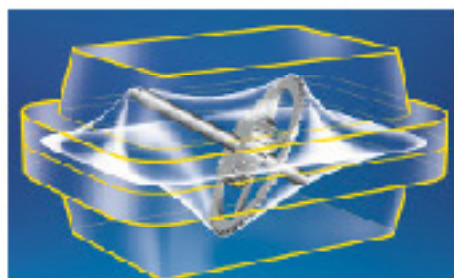

Schéma	Longueur (1) mm	Largeur (2) mm	Hauteur (3) mm	Référence	Quantité	
	275	150	8	1312		
			12.5	1313		
			25	1314		
			37.5	1315		
			50	1316		
			62.5	1317		
			75	1318		
	275	150	8	1326		
			12.5	1327		
			25	1328		S
			37.5	1329		
			50	1330		
			62.5	1331		
			75	1332		
	275	175	8	1364		
			12.5	1365		
			25	1366		
			37.5	1367		
			50	1368		
			62.5	1369		
			75	1370A		
			87.5	1371		
	275	175	8	1380		
			12.5	1381		
			25	1382		
			37.5	1383		
			50	1384		
			62.5	1385		
			75	1386		
			87.5	1387		

- L = Crochet d'ouverture
- C = Charnière
- Les numéros d'article concernent toujours des 1/2 boîtes
- S = Livrable du stock (sans frais d'outillage)

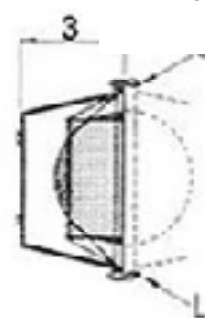
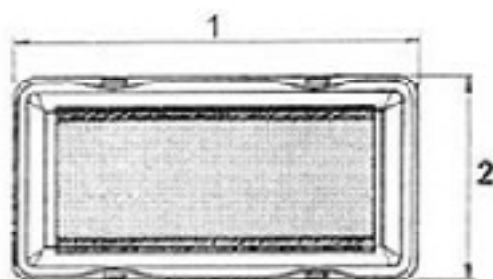
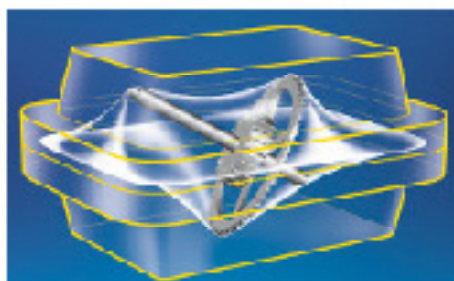

Schéma	Longueur (1) mm	Largeur (2) mm	Hauteur (3) mm	Référence	Quantité
	275	200	8	1441	
			12.5	1442	
			25	1443	S
			37.5	1444	
			50	1445	S
			62.5	1446	
			75	1447	S
			100	1449	S
	300	50	8	1465	
			12.5	1466	
			25	1467	S
	300	75	8	1483.1	
			12.5	1484.1	S
			25	1485.1	S
			37.5	1486	
	300	100	8	1502	
			12.5	1503	
			25	1504	S
			37.5	1505	
			50	1506	
	300	100	8	1507	
			12.5	1508	
			25	1509	S
			37.5	1510	
			50	1511	S

- L = Crochet d'ouverture

- C = Charnière

- Les numéros d'article concernent toujours des 1/2 boîtes

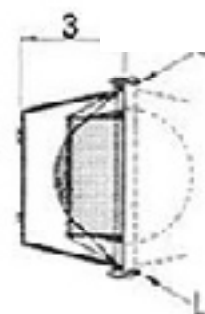
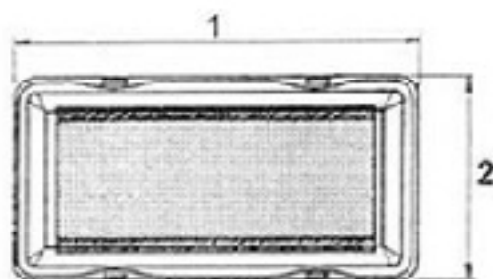
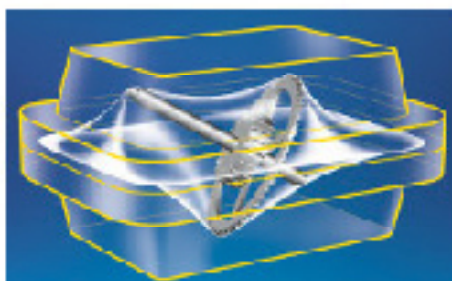
- S = Livrable du stock (sans frais d'outillage)



Schéma	Longueur (1) mm	Largeur (2) mm	Hauteur (3) mm	Référence	Quantité	
	300	125	8	1530		
			12.5	1531		
			25	1532		S
			50	1534		
			62.5	1535		
	300	125	37.5	1533.1		S
	300	125	8	1542		
			12.5	1543		
			25	1544		S
			37.5	1545		
			50	1546		
			62.5	1547		
	300	150	8	1575		
			12.5	1576		
			25	1577		
			37.5	1578		S
			50	1579		
			62.5	1580		
			75	1581		
	300	150	8	1589		S
			12.5	1590		S
			25	1591		S
			37.5	1592		S
			50	1593		
			62.5	1594		
			75	1595		
	300	150	8	1603		S
			12.5	1604		S
			25	1605		S
			37.5	1606		S
			50	1607		
			62.5	1608		
			75	1609		

- L = Crochet d'ouverture

- C = Charnière

- Les numéros d'article concernent toujours des 1/2 boîtes

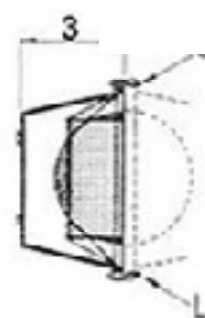
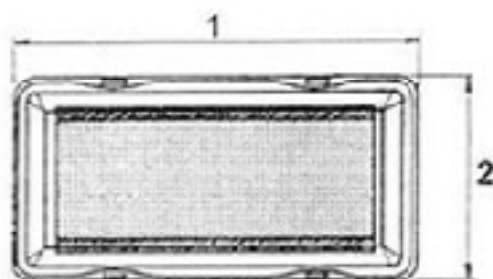
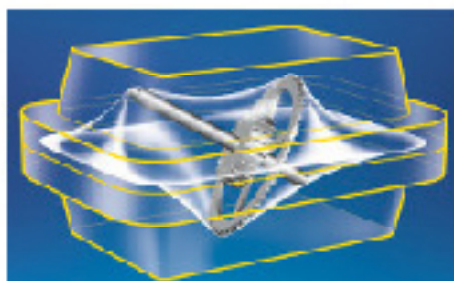





Schéma	Longueur (1) mm	Largeur (2) mm	Hauteur (3) mm	Référence	Quantité
	300	300	12.5	2324	
			25	2325	S
			37.5	2326	
	350	200	8	2318	
			12.5	2319	S
			25	2320	S
			37.5	2321	
			50	2322	
	400	200	12.5	2608	
			25	2609	S
			37.5	2610	
	400	300	12.5	2632	
			25	2633	S
			37.5	2634	
	400	400	12.5	2656	
			25	2657	S
			37.5	2658	
			12.5	3004	

	500	200	25	3005		
			37.5	3006		
	500	300	12.5	3028		
			25	3029		S
			37.5	3030		
	500	400	12.5	3052		
			25	3054		S
			37.5	3055		
	500	500	12.5	3076		
			25	3077		S
			37.5	3078		
	600	200	12.5	3496		
			25	3497		S
			37.5	3498		
	600	300	12.5	3520		
			25	3521		S
			37.5	3522		
			12.5	3544		

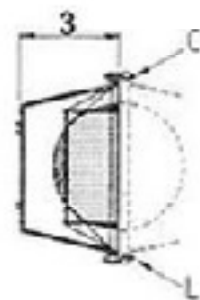
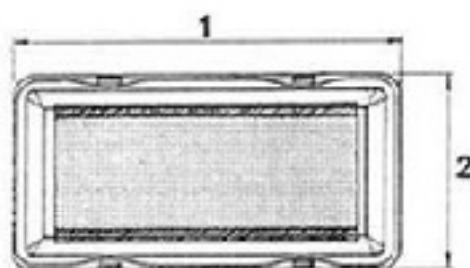
	800	400	25	3545	
			37.5	3546	

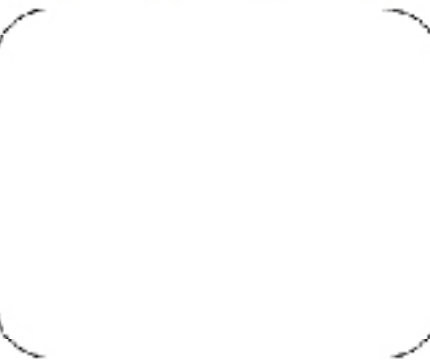
- L = Crochet d'ouverture
- C = Charnière
- Les numéros d'article concernent toujours des 1/2 boîtes
- S = Livrable du stock (sans frais d'outillage)

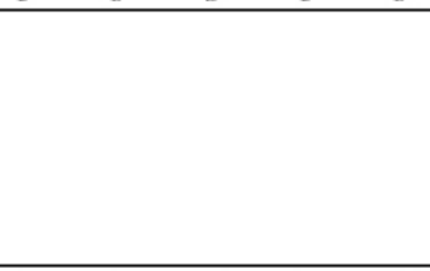
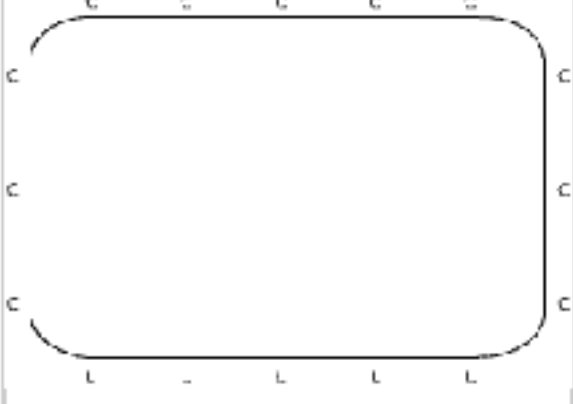
½ boîte avec membrane et ½ cadre - NOIR



Schéma	Longueur mm	Largeur mm	Hauteur mm	Référence	Quantité	
	100	75	12.5	23 CAN		S
			25	24 CAN		S
			37.5	25 CAN		S
	125	125	12.5	97 CAN		S
			25	98 CAN		S
			37.5	99 CAN		S
	150	75	12.5	129 CAN		S
			25	130 CAN		S
	150	150	12.5	224 CAN		S
			25	225 CAN		S
			32.5	226 CAN		S
	175	75	12.5	252 CAN		S
			25	253 CAN		S
	175	100	12.5	275 CAN		S
			25	276 CAN		S
	200	150	12.5	539 CAN		S
			25	540 CAN		S
			37.5	541 CAN		S
			50	542 CAN		S

- L = Crochet d'ouverture

- C = Charnière

- Les numéros d'article concernent toujours des 1/2 boîtes

- S = Livrable du stock (sans frais d'outillage)



Schéma	Longueur mm	Largeur mm	Hauteur mm		Référence	Quantité
	100	75	12.5	23 CAB		S
			25	24 CAB		S
			37.5	25 CAB		S
	125	125	12.5	97 CAB		S
			25	98 CAB		S
			37.5	99 CAB		S
	150	75	12.5	129 CAB		S
			25	130 CAB		S
	150	150	12.5	224 CAB		S
			25	225 CAB		S
			32.5	226 CAB		S
	175	75	12.5	252 CAB		S
			25	253 CAB		S
	175	100	12.5	275 CAB		S
			25	276 CAB		S
	200	150	12.5	539 CAB		S
			25	540 CAB		S
			37.5	541 CAB		S
			50	542 CAB		S

- L = Crochet d'ouverture
- C = Charnière
- Les numéros d'article concernent toujours des 1/2 boîtes
- S = Livrable du stock (sans frais d'outillage)

Cadres pliables avec membrane élastique

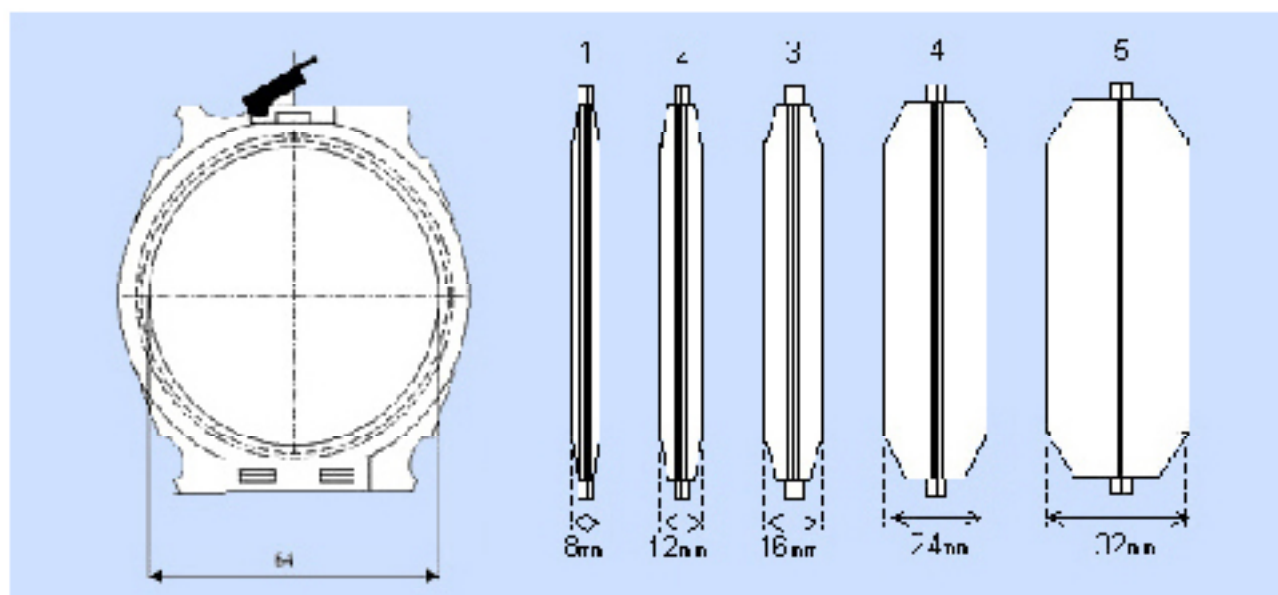
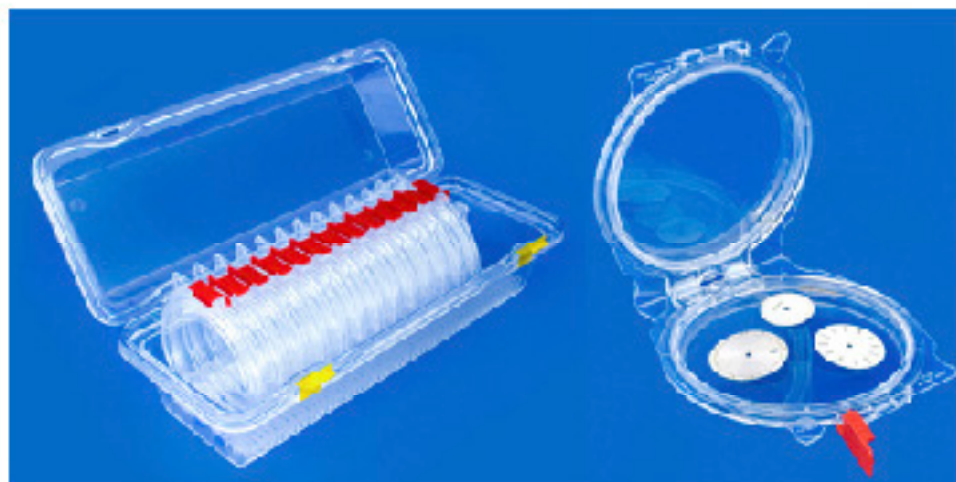

Désignation	Epaisseur mm	Référence	Quantité de cadres dans la boîte de conditionnement	Poids g.	Quantité
Cadres pliables	2 x 4 = 8	8.76	25	12.5	S
Cadres pliables	2 x 6 = 12	12.76	17	13	S
Cadres pliables	2 x 8 = 16	16.76	12	15	S
Cadres pliables	2 x 12 = 24	24.76	8	18	S
Cadres pliables	2 x 16 = 32	32.76	6	21	S
Boîte de conditionnement	40 (couvercle)	1247 B		253	S
	50 (fond)	1248.1			S

- Remarque: les cadres pliables peuvent être livrés avec cocque dure également.
- S = Livrable du stock (sans frais d'outillage)

Boîte à membrane avec pitons pour 10/20/30 cadra...

25c



Schéma	Longueur (1) mm	Largeur (2) mm	Hauteur mm	Référence	Quantité	
	250	125	8	1016 B 10		S
			8	1016 B 20		S
			8	1016 B 30		S

Remarque: Chaque cadran est tenu en place par un piton. La membrane du couvercle maintient le cadran en place sans le rayer

- L = Crochet d'ouverture

- C = Charnière

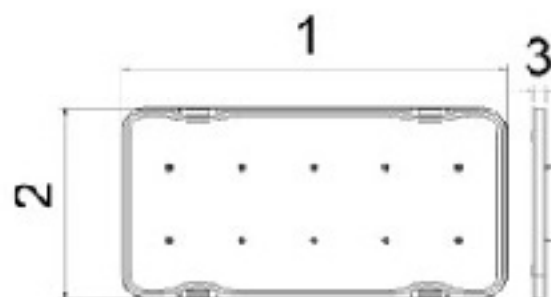
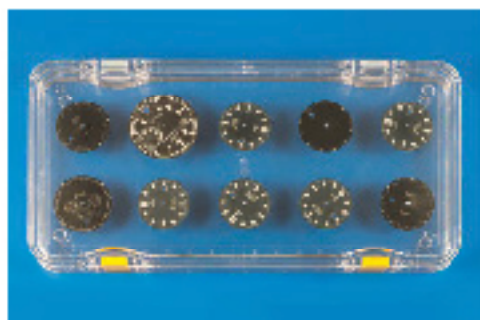
- S = Livrable du stock (sans frais d'outillage)

Plateaux empilables

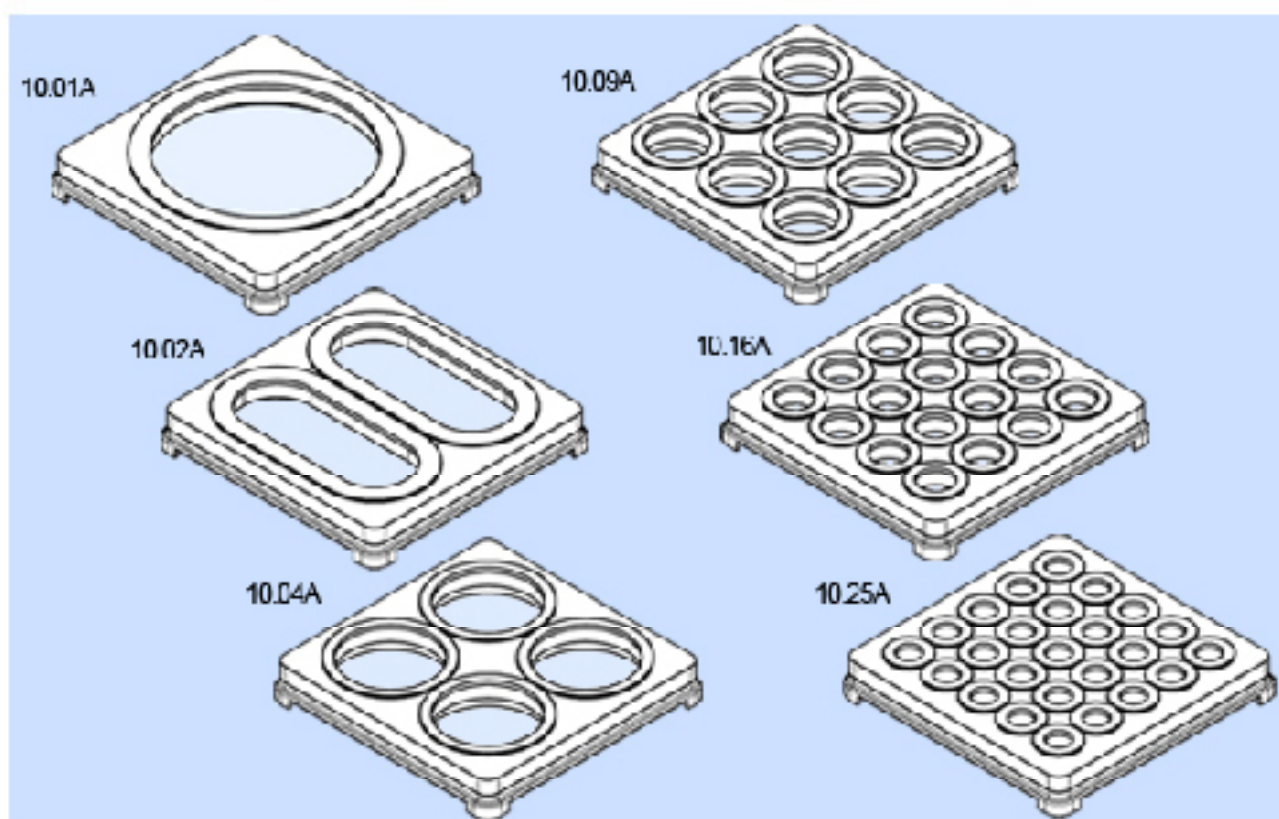

Référence	Plateaux empilables à deux membranes mm	Nb de cavités	Dimensions des cavités mm	Poids g	Quantité
10.01A	75 x 75 x 10	1	∅ 45 x 6.5	18	S
10.02A	75 x 75 x 10	2	45 x 17 x 6.5	20	S
10.04A	75 x 75 x 10	4	∅ 17 x 6.5	24	S
10.09A	75 x 75 x 10	9	∅ 12.5 x 5	27	S
10.16A	75 x 75 x 10	16	∅ 7.5 x 5	31	
10.25A	75 x 75 x 10	25	∅ 5 x 5	33	

- S = Livrable du stock (sans frais d'outillage)

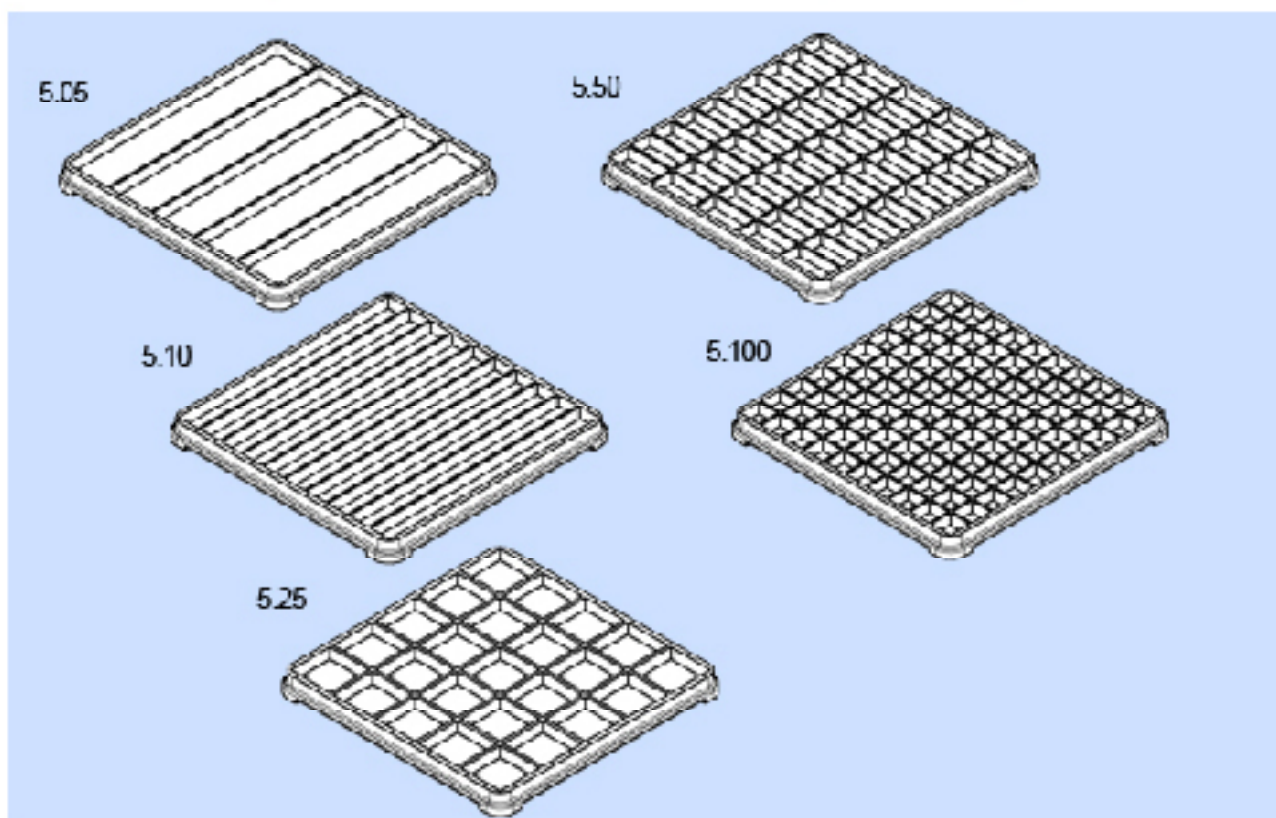
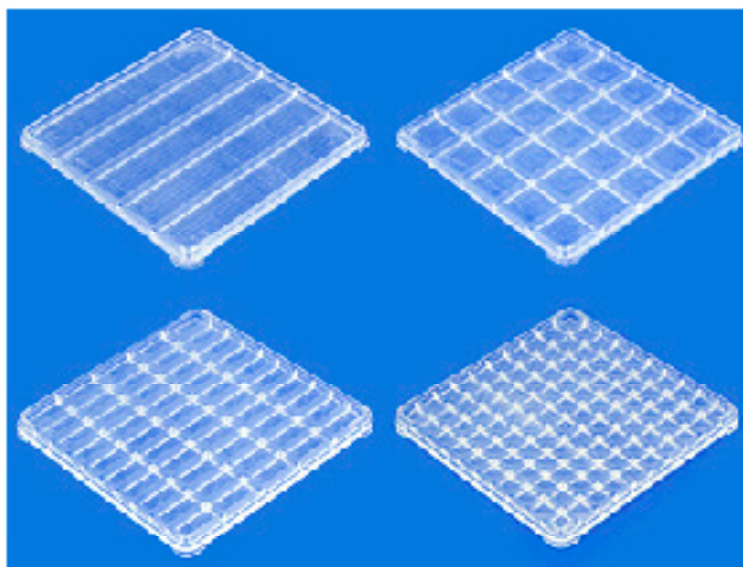

Référence	Plateaux empilables mm	Nb de cavités	Dimensions des cavités mm	Poids g	Quantité
5.05	75 x 75 x 5	5	69 x 13 x 3.7	9.6	S
5.10	75 x 75 x 5	10	69 x 6 x 3.7	10.6	S
5.25	75 x 75 x 5	25	13 x 13 x 3.7	10.4	S
5.50	75 x 75 x 5	50	13 x 6 x 3.7	11.4	S
5.100	75 x 75 x 5	100	6 x 6 x 3.7	12.3	S



- S = Livrable du stock (sans frais d'outillage)



<p>①</p>	<p>②</p>	<p>① 2x 1/2 boîte 37B 2x 10.01A</p>
<p>③</p>	<p>④</p>	<p>② 2x 1/2 boîte 285B 4x 5.25 4x 5.05</p>
		<p>③ 2x 1/2 boîte 977B 2x 10.01A 4x 5.25 2x 10.04A</p>
		<p>④ 2x 1/2 boîte 410B 2x 10.01A 2x 10.02A 2x 10.04A 2x 10.09A</p>

Boîtes à fourniture



Schéma	Ø1 mm	Ø2 mm	H mm	Hi mm	g gr.	Matière	Couleur	N° de commande	Quantité
	34	29,5	15	13	3	Polystyrène	Transparent	1235	S
	41	36,5	15,5	13	5,2			1236	S





Schéma	Ø1 mm	Ø2 mm	H mm	Hi mm	g gr.	Matière	Couleur	N° de commande	Quantité
	28	22,5	6,5	3,8	2	Polystyrène	Transparent	1240	S

Remarques

- C: crans pour ouverture
- S: livrable de stock (sans frais d'outillage)

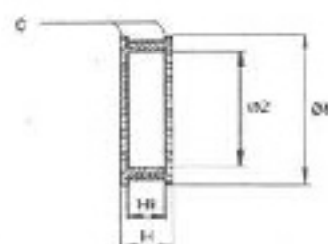

Schéma	D mm	Di mm	H mm	Hi mm	g mm	Matière	Couleur	N° de commande	Quantité
	15	11,5	18	13	1,2	Polystyrène	Transparent	1223	S
	15	12	34	30	2,8			1222	S
	23,5	20	12	9	2			1224	S
	23,5	20	18	12	2,2			1225	S
	32,5	27,5	14	10,5	4,1			1279	S
	32,5	28,5	18	12,5	5			1226	S
	39,5	35	18	12	6,2			1227	S
	39,5	35	22	18	8			1228	S
	52	48	18	14	11			1229	S
	52	47,5	28	21,5	14			1230	S

Remarques

- S: livrable de stock (sans frais d'outillage)

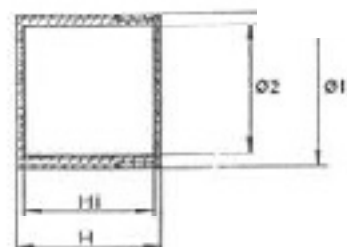

Schéma	L mm	Li mm	I mm	li mm	H mm	Hi mm	g gr.	Matière	Couleur	N° de commande	Quantité
	24	18	24	18	19	15,5	4,5	Polystyrène	Transparent	1277	S
	48	43	48	43	19	15,5	12			1280	S
	36	32	36	32	16	12	7			1437	S



Schéma	L mm	Li mm	I mm	li mm	H mm	Hi mm	g gr.	Matière	Couleur	N° de commande	Quantité
	48	43	24	19	19	16	7,5	Polystyrène	Transparent	1278	S
	56	51,5	20	15,5	19	15	8			1395	S
	54	49	24	19,5	25	22	11			1333	S
	58	53	30,5	26	30,5	27,5	13,5			1457	S

Remarques

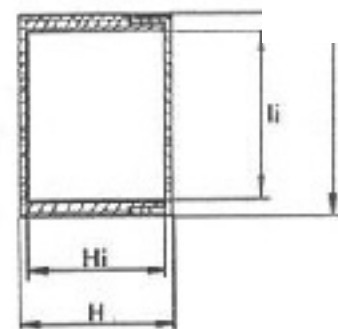
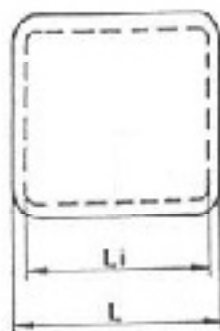
- S: livrable de stock (sans frais d'outillage)

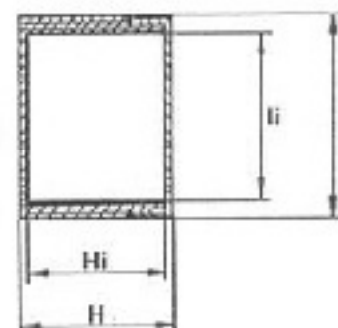
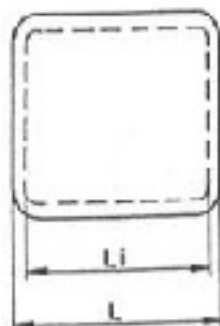

Schéma	L mm	Li mm	I mm	li mm	H mm	Hi mm	g gr.	Matière	Couleur	N° de commande	Quantité
	65,5	60,5	50	46	17	11,5	17	Polystyrène	Transparent	1365.1	S
	65,5	60,5	50	46	17	11,5	19			1365.4	S

			65,5	60,5	50	46	17	11,5	20			1365.6	

Remarques

- C: crans d'empilement
- S: livrable de stock (sans frais d'outillage)

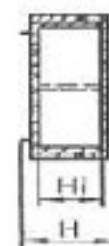
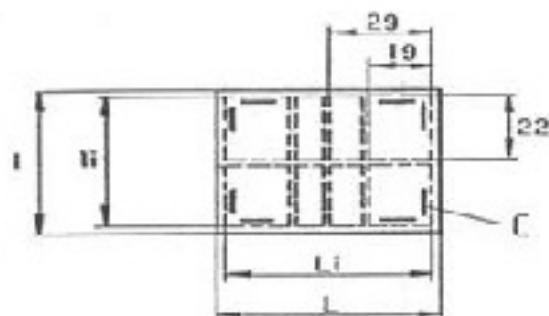

Schéma	L mm	Li mm	I mm	li mm	H mm	Hi mm	g gr.	Matière	Couleur	N° de commande	Quantité
	82	73	54	45	18	12	30	Polystyrène	bleu jaune rouge	81-1 bleu 81-1 jaune 81-1 rouge	S
	82	73	54	45	18	12	32			81-4 bleu 81-4 jaune 81-4 rouge	S
	82	73	54	45	18	12	32			81-7 bleu 81-7 jaune 81-7 rouge	S



Schéma	L mm	Li mm	I mm	li mm	H mm	Hi mm	g gr.	Matière	Couleur	N° de commande	Quantité
	120	112	70	61	15	9	50	Polystyrène	bleu clair	1241-9 SP	S
	120	112	70	61	15	9	50			1241-10	S
	120	112	70	61	15	9	52			1241-12 SP	S

Remarques

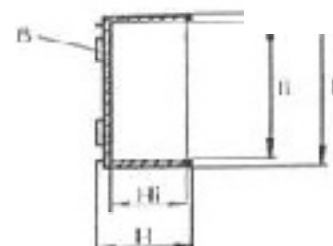
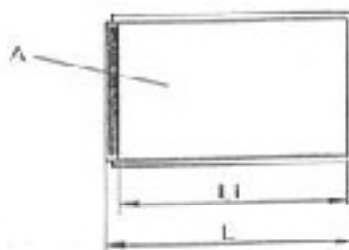
- A: couvercle coulissant transparent
- B: crans d'empilement
- S: livrable de stock (sans frais d'outillage)



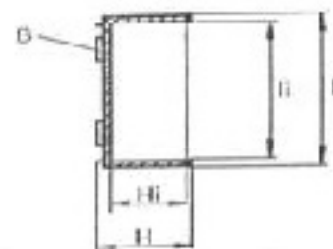
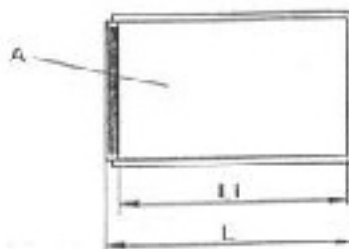



Schéma	L mm	Li mm	I mm	li mm	H mm	Hi mm	g gr.	Matière	Couleur	N° de commande	Quantité
	120	112	70	61	25	18,5	63	Polystyrène	bleu jaune rouge	1213-1 bleu 1213-1 jaune 1213-1 rouge	S
	120	112	70	61	25	18,5	66			1213-2 bleu 1213-2 jaune 1213-2 rouge	S
	120	112	70	61	25	18,5	66			1213-3 bleu 1213-3 jaune 1213-3 rouge	S
	120	112	70	61	25	18,5	70			1213-4 bleu 1213-4 jaune 1213-4 rouge	S
	120	112	70	61	25	18,5	69			1213-4 SP bleu 1213-4 SP jaune 1213-4 SP rouge	S
	120	112	70	61	25	18,5	70			1213-8 bleu 1213-8 jaune 1213-8 rouge	S
	120	112	70	61	25	18,5	75			1213-8 bleu 1213-8 jaune 1213-8 rouge	S
	120	112	70	61	25	18,5	76			1213-10 bleu 1213-10 jaune 1213-10 rouge	S
	120	112	70	61	25	18,5	81			1213-15 bleu 1213-15 jaune 1213-15 rouge	S
	120	112	70	61	25	18,5	77			1213-15SP bleu 1213-15SP	S

jaune
1213-15SP
rouge

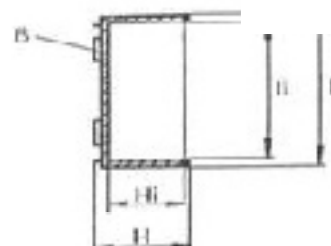
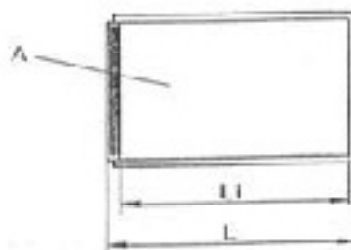
41

Remarques

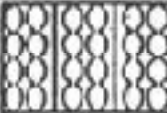
- A: couvercle coulissant transparent
- B: crans d'empilement
- S: livrable de stock (sans frais d'outillage)

Schéma	g. gr.	
	93	1 x No 1213-1 (page 35) 6 x No 408 (page 37)
	95	1 x No 1213-3 (page 35) 24 x No 1223 (page 32)
	96	1 x No 1213-1 (page 35) 28 x No 1223 (page 32)

Remarques

- A: couvercle coulissant transparent
- S: livrable de stock (sans frais d'outillage)



Schéma	L mm	Li mm	I mm	li mm	H mm	Hi mm	g gr.	Matière	Couleur	N° de commande	Quantité
	192	182	102	90	17	10	100	Polystyrène	bleu clair	1367-1	S
	192	182	102	90	17	10	102			1367-3 SP	S
	192	182	102	90	17	10	105			1367-10	S
	192	182	102	90	34	25	110			1368-1	S
	192	182	102	90	34	25	120			1368-2	S
	192	182	102	90	34	25	125			1368-3 SP	S
	192	182	102	90	34	25	130			1368-3 LG	S
	192	182	102	90	34	25	125			1368-4	S
	192	182	102	90	34	25	132			1368-5	S
	192	182	102	90	34	25	140			1368-10	S
	192	182	102	90	50	42	180			1368-1 A	S

Remarques :

- A: couvercle coulissant transparent
- B: crans d'empilement
- S: livrable de stock (sans frais d'outillage)



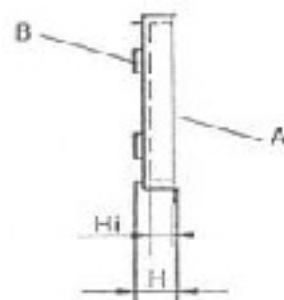
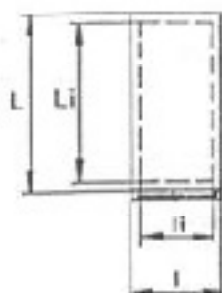
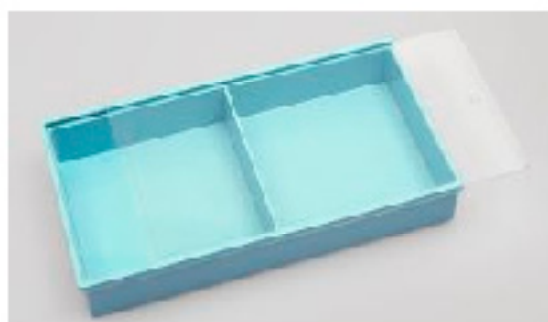

Schéma	L mm	Li mm	I mm	li mm	H mm	Hi mm	g gr.	Matière	Couleur	N° de commande	Quantité	
	192	182	102	90	64	57	180	Polystyrène	bleu clair	1369-1		S
	192	182	102	90	64	57	195			1369-3 SP		S

Remarques

- A: couvercle coulissant transparent
- B: crans d'empilement
- S: livrable de stock (sans frais d'outillage)

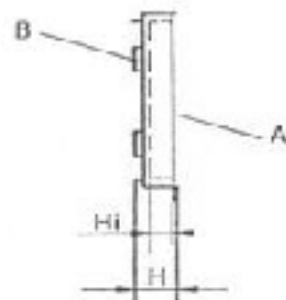
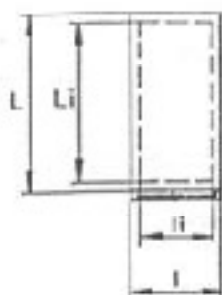
Boîtes de travail





Schéma	L mm	Li mm	I mm	li mm	H mm	Hi mm	g gr.	Matière	Couleur	N° de commande	Quantité
	220	210	105	94	21	15	120	Polystyrène	bleu clair	1429-1	S
	220	210	105	94	21	15	145			1429-10	S

Boîtes de travail



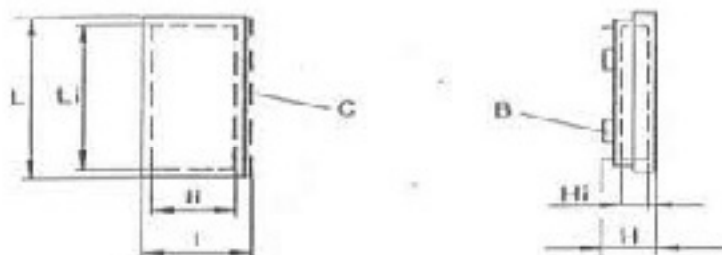

Schéma	L mm	Li mm	I mm	li mm	H mm	Hi mm	g gr.	Matière	Couleur	N° de commande	Quantité
	296	285	135	120	32	22	260	Polystyrène	bleu clair	1345-1	S
	296	285	135	120	32	22	300			1345-10	S

Remarques

- B: crans d'empilement
- C: couvercle transparent à charnière
- S: livrable de stock (sans frais d'outillage)

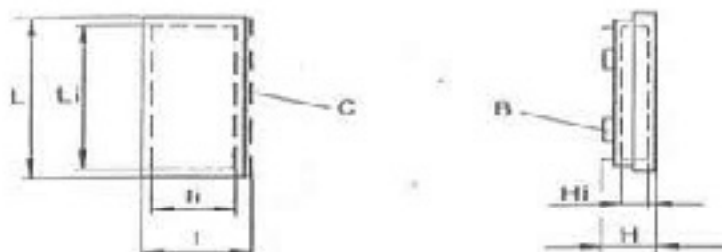

Schéma	L mm	Li mm	I mm	li mm	H mm	Hi mm	g gr.	Matière	Couleur	N° de commande	Quantité
	121	10	55	8	11	4,5	40	Polystyrène	bleu clair	1321-50	S
	152	13	70	11	11	4,5	60			1322-50	S
	220	20	105	17,5	11	4,5	130			1323-50	S
	340	31,5	100	17,5	11	4,5	175			1324-50	S

Boîtes de travail

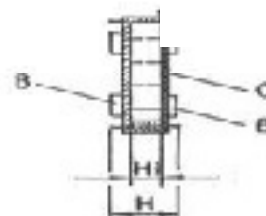
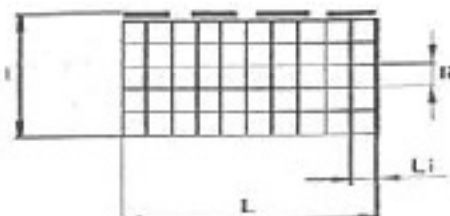
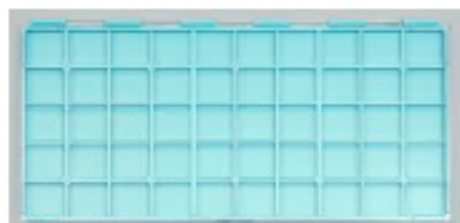

Schéma	L mm	Li mm	I mm	li mm	H mm	Hi mm	g gr.	Matière	Couleur	N° de commande	Quantité
	350	32	180	32	16	9,5	350	Polystyrène	bleu clair	1380-50	S

Remarques

- B: crans d'empilement
- C: couvercle transparent à charnière
- S: livrable de stock (sans frais d'outillage)

Boîtes de travail

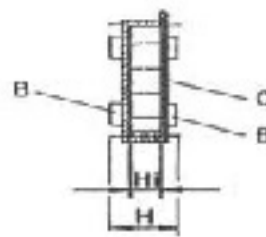
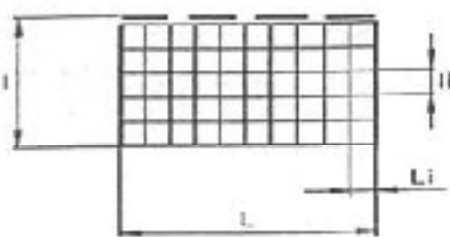



Schéma	L mm	Li mm	I mm	li mm	H mm	Hi mm	g gr.	Matière	Couleur	N° de commande	Quantité
	220	210	105	94	21	15	120	Polystyrène	bleu clair	1429-1	S
	220	210	105	94	21	15	145			1429-10	S

Boîtes de travail



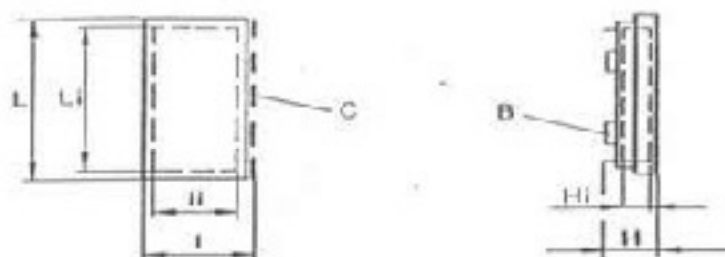

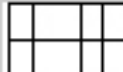
Schéma	L mm	Li mm	I mm	li mm	H mm	Hi mm	g gr.	Matière	Couleur	N° de commande	Quantité
	296	285	135	120	32	22	280	Polystyrène	bleu clair	1345-1	S
	296	285	135	120	32	22	300			1345-10	S

Remarques

- B: crans d'empilement
- C: couvercle transparent à charnière
- S: livrable de stock (sans frais d'outillage)

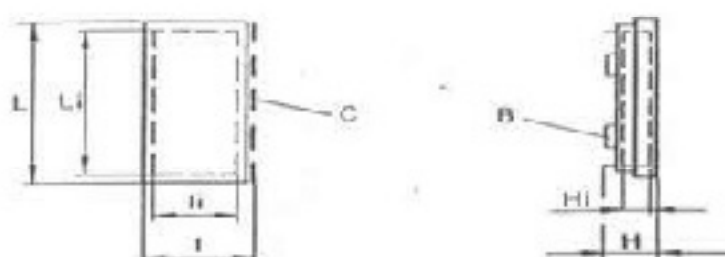

Schéma	L mm	Li mm	I mm	li mm	H mm	Hi mm	g gr.	Matière	Couleur	N° de commande	Quantité
	121	10	55	8	11	4,5	40	Polystyrène	bleu clair	1321-50	S
	152	13	70	11	11	4,5	60			1322-50	S
	220	20	105	17,5	11	4,5	130			1323-50	S
	340	31,5	100	17,5	11	4,5	175			1324-50	S

Boîtes de travail

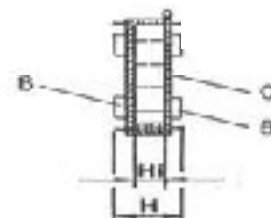
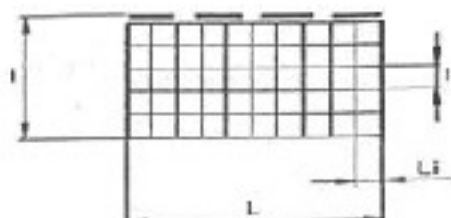
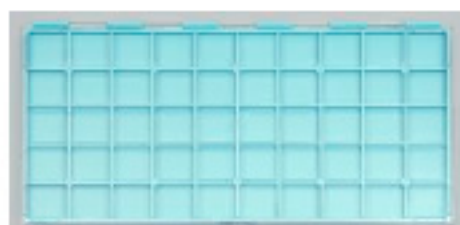

Schéma	L mm	Li mm	I mm	li mm	H mm	Hi mm	g gr.	Matière	Couleur	N° de commande	Quantité
	350	32	180	32	16	9,5	350	Polystyrène	bleu clair	1360-50	S

Remarques

- B: crans d'empilement
- C: couvercle transparent à charnière
- S: livrable de stock (sans frais d'outillage)

Plateaux de travail

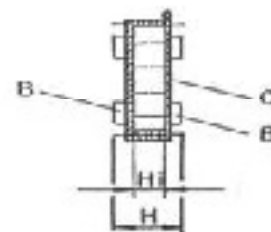
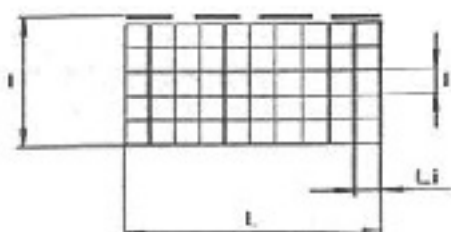

Schéma	L mm	I mm	H mm	Li mm	li mm	Hi mm	g gr.	Matière	Couleur	N° de commande	Quantité
	195	92	10,5	8	15	2,8	70	Polystyrène	bleu clair	1411-100 (1) (2)	S
	235	125	10,5	10	22	2,8	105			1412-100 (1) (2)	S



Schéma	L mm	I mm	H mm	Li mm	li mm	Hi mm	g gr.	Matière	Couleur	N° de commande	Quantité
	195	92	15,5	17	15	2,8	85	Polystyrène	bleu clair	1411-50 (1) (2)	S
	215	141	11,5	19	25	3,3	100			1413-50 (1) (2)	S
	330	188	15,5	30,5	30,5	6	210			1414-50 (1) (2)	S

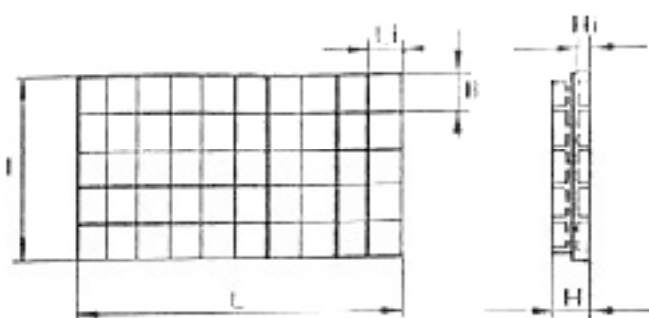
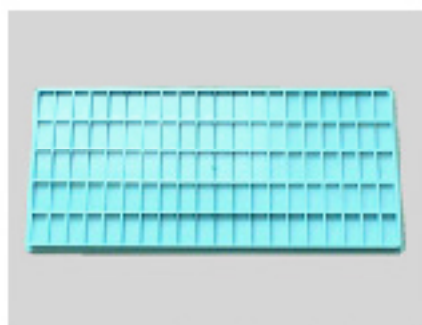

Schéma	L mm	I mm	H mm	Li mm	li mm	Hi mm	g gr.	Matière	Couleur	N° de commande	Quantité
	345	174	13	32	32	10	185	Polystyrène	bleu clair	1415-50 (3)	S

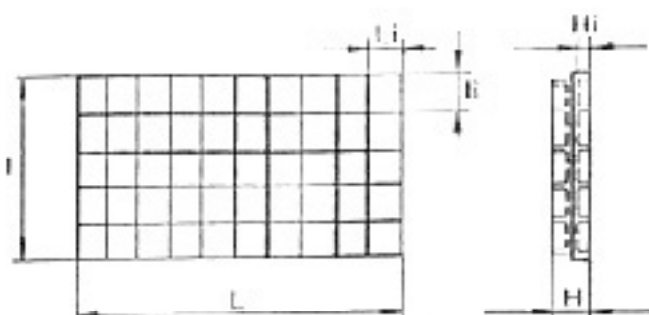

Schéma	D mm	H mm	g gr.	Matière	Couleur	N° de commande	Quantité	
	30	9	5	Phénol-mélamine (1)	bleu blanc jaune rouge vert	358 bleu 358 blanc 358 jaune 358 rouge 358 vert		S
	50	11	10		bleu blanc jaune rouge blanc	359 bleu 359 blanc 359 jaune 359 rouge 359 vert		S
	70	13	25	Phénol-mélamine (1)	bleu blanc jaune rouge vert	360 bleu 360 blanc 360 jaune 360 rouge 360 vert		S

Remarques

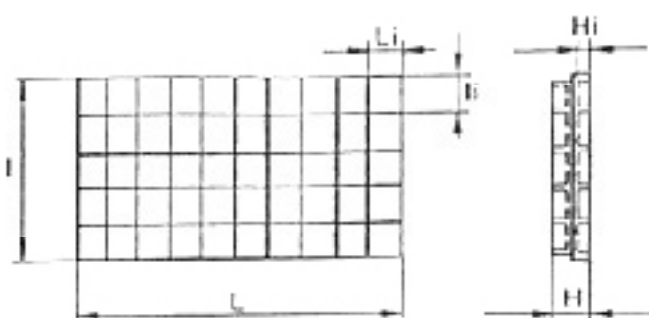
- (1): résiste aux solvants
- A: Rebord d'empilement
- S: livrable de stock (sans frais d'outillage)

Cloche

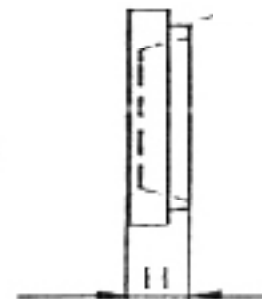



Schéma	D	H	Hi	g	Matière	Couleur	N° de commande	Quantité	
	95	62	46	30	Iuran	Transparent	1203		S

Dessous de cloche



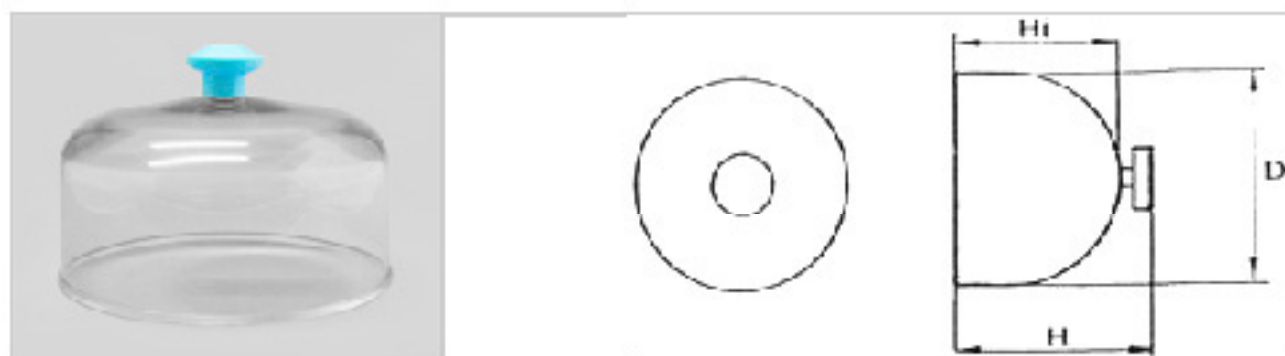

Schéma	D	H	D1	D2	g	Matière	Couleur	N° de commande	Quantité	
	104	13	89	31.8	20	Polystyrène	bleu clair	1204-6		S

Remarques

- S: livrable de stock (sans frais d'outillage)

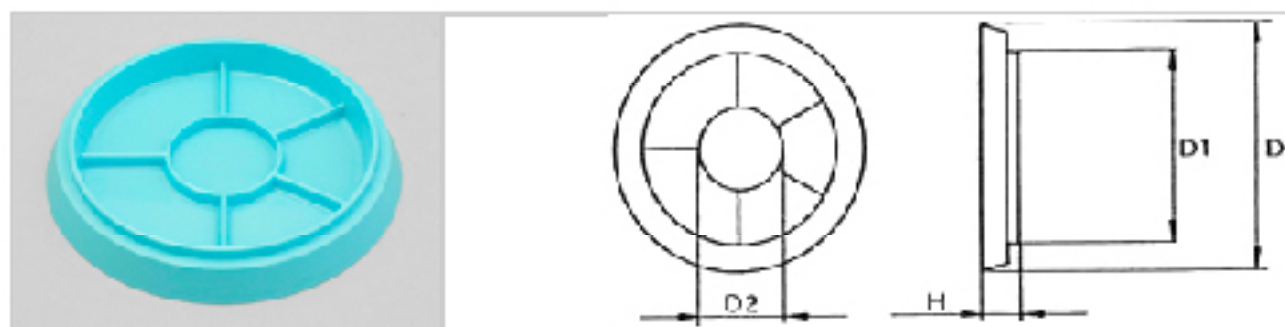
Boîte à membrane en grappe



Schéma	d mm	e mm	f mm	Ø mm	g gr.	Longueur (1) mm	Largeur ((2) mm	Hauteur (3) mm	Référence	Quantité
	18	18	9	25	10	240	79	17.8	12.12T	S
	18	18	9	25	10	120	79	17.8	12.12.T11	S
	18	18	9	25	10	39	39	17.8	12.12T4	S

- positions 12.12 T et 12.12 T 11 se livrent en grappe fond et couvercle séparés.

- position 12.12 T 4 se livre par pièce fond et couvercle ensemble en sachet de 100 ou 200 pièces .

- S = Livrable du stock (sans frais d'outillage)

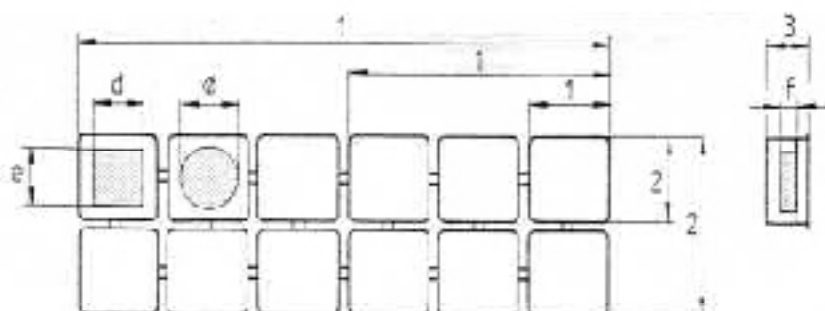
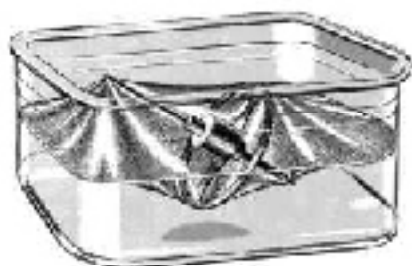
g : poids maximum de l'objet emballé.

Boîte à membrane ronde







Schéma	d	e	f	Ø	g	Hauteur (1) mm	Ø (2) mm	Référence	Quantité
	mm	mm	mm	mm	gr.				
	40	40	9	54	100	17	82	17.82.1	S
	40	40	20	54	200	40	82	40.82.1	S
	77	77	20	108	900	42	165	42.165.1	S
	77	77	40	108	1800	84	165	84.165.1	S

- positions 17.82.1 et 40.82.1 se livrent fond et couvercle séparés.
- positions 42.165.1 et 84.165.1 se livrent fond et couvercle ensemble.
- g : poids maximum de l'objet emballé.
- S = Livrable du stock (sans frais d'outillage)

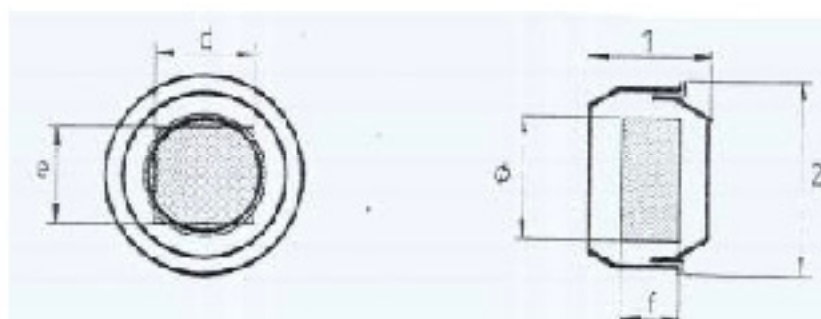
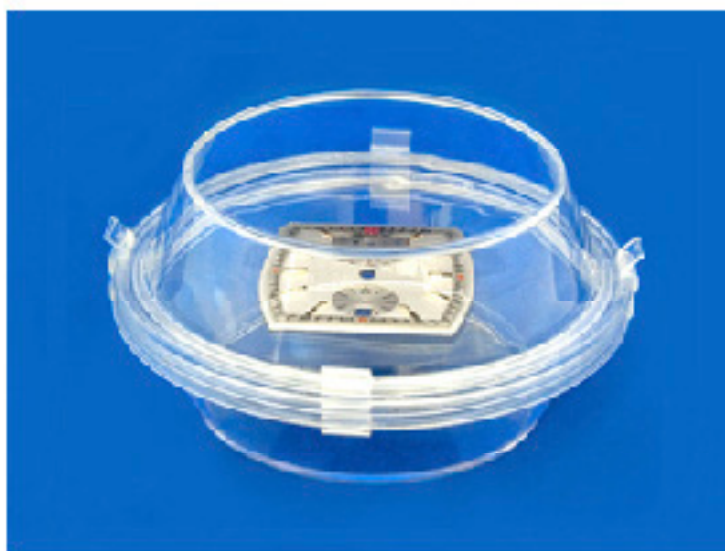

Schéma	Hauteur (1) mm	Diamètre(Ø) mm	Référence	Quantité	
	12.5	100	12.5.100.1		
	12.5	150	12.5.150.1		

- se livrent fond et couvercle ensemble
- L = Crochet d'ouverture
- C = Charnière
- S = Livrable du stock (sans frais d'outillage)



Schéma	Longueur (l) mm	Largeur (l) mm	Hauteur (h) mm	Rayon(R) mm	Référence	Quantité
	100	50	4	25	11R	
	100	75	4	25	22R	
	100	100	4	25	31R	
	150	50	4	25	114R	
	150	75	4	25	128R	
	150	100	4	25	147R	
	150	125	4	25	183R	
	150	150	4	25	222R	
	250	150	4	25	1016R	S

- se livrent fond et couvercle ensemble

- L = Crochet d'ouverture

- C = Charnière

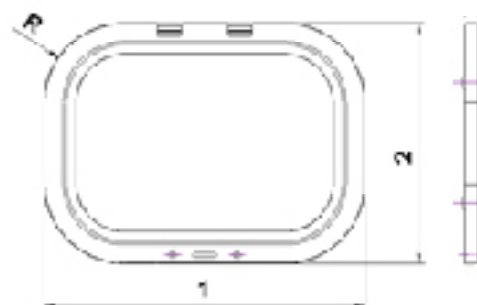

Schéma	Longueur (1) mm	Largeur (2) mm	Hauteur (3) mm	Rayon(R) mm	Référence	Quantité
	125	100	12.5	50	12.5.100.125.1	
	150	100	12.5	50	12.5.100.150.1	
	175	100	12.5	50	12.5.100.175.1	
	175	150	12.5	75	12.5.150.175.1	
	200	100	12.5	50	12.5.100.200.1	
	200	150	12.5	75	12.5.150.200.1	
	225	100	12.5	50	12.5.100.225.1	
	225	150	12.5	75	12.5.150.225.1	
	250	100	12.5	50	12.5.100.250.1	
	250	150	12.5	75	12.5.150.250.1	

- se livrent fond et couvercle ensemble

- L = Crochet d'ouverture

- C = Charnière

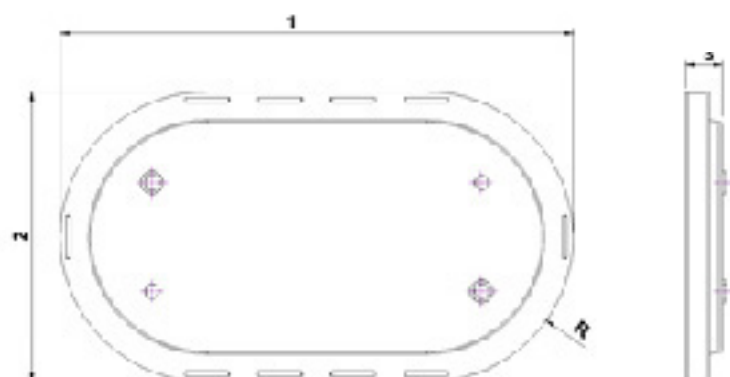
Boîte étanche avec membrane élastique

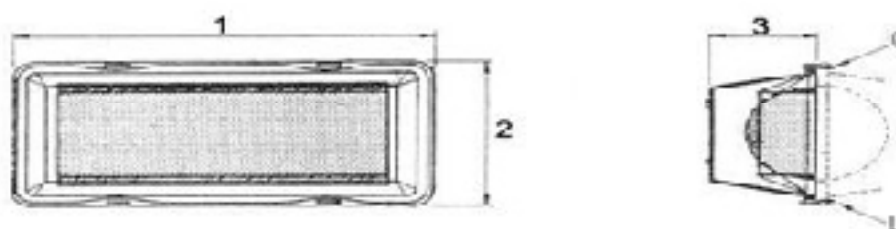

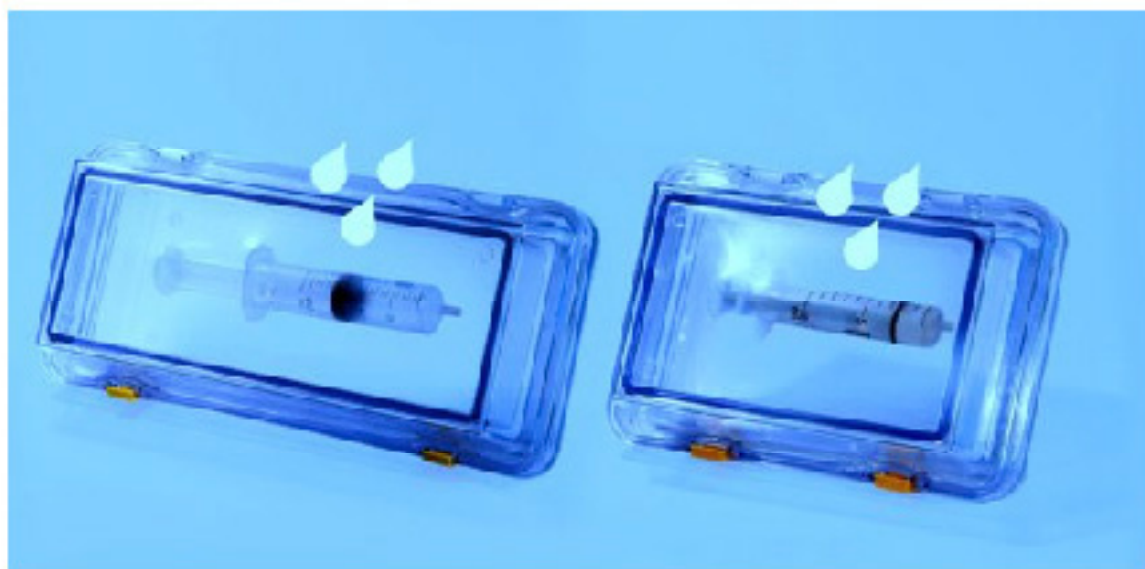
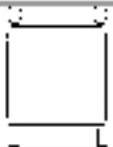

Schéma	Longueur (1) mm	Largeur (2) mm	Hauteur (3) mm	Référence	Quantité	
	150	125	37.5	198 E		S
	275	125	37.5	1282 E		S

Les ½ boîtes à membrane des pages 3 - 22 du site Inca peuvent être construites en modèle étanche. Demandez une offre par fax ou par mail (baillodfr@bluewin.ch) en indiquant le numéro de la ½ boîte à membrane que vous désirez en modèle étanche.